



HAL
open science

Study of passive sampler calibration (Chemcatcher®) for environmental monitoring of organotin compounds: Matrix effect, concentration levels and laboratory vs in situ calibration

Antoine Garnier, Chrystelle Bancon-Montigny, Sophie Delpoux, Sylvie Spinelli, Murielle Avezac, Catherine Gonzalez

► To cite this version:

Antoine Garnier, Chrystelle Bancon-Montigny, Sophie Delpoux, Sylvie Spinelli, Murielle Avezac, et al.. Study of passive sampler calibration (Chemcatcher®) for environmental monitoring of organotin compounds: Matrix effect, concentration levels and laboratory vs in situ calibration. *Talanta*, 2020, 219, pp.121316. 10.1016/j.talanta.2020.121316 . hal-02900334

HAL Id: hal-02900334

<https://imt-mines-ales.hal.science/hal-02900334>

Submitted on 18 Jul 2022

HAL is a multi-disciplinary open access archive for the deposit and dissemination of scientific research documents, whether they are published or not. The documents may come from teaching and research institutions in France or abroad, or from public or private research centers.

L'archive ouverte pluridisciplinaire **HAL**, est destinée au dépôt et à la diffusion de documents scientifiques de niveau recherche, publiés ou non, émanant des établissements d'enseignement et de recherche français ou étrangers, des laboratoires publics ou privés.



Distributed under a Creative Commons Attribution-NonCommercial | 4.0 International License

Title

Study of passive sampler calibration (Chemcatcher®) for environmental monitoring of organotin compounds: matrix effect, concentration levels and laboratory vs in situ calibration

**Antoine Garnier^{1,2}, Chrystelle Bancon-Montigny², Sophie Delpoux², Sylvie Spinelli¹,
Murielle Avezac¹, Catherine Gonzalez¹**

(antoine.garnier@umontpellier.fr; antoine.garnier@mines-alès.fr; chrystelle.bancon-montigny@umontpellier.fr ; sophie.delpoux@umontpellier.fr ;
sylvie.spinelli@mines-ales.fr ; murielle.avezac@mines-ales.fr ; catherine.gonzalez@mines-ales.fr)

¹*Laboratoire de Génie de l'Environnement Industriel, IMT Mines Alès, 1 Rue Jules Renard, 30100 Alès,
France*

²*HydroSciences Montpellier, University of Montpellier, 300 Avenue du Professeur Emile Jeanbrau,
34090 Montpellier, France*

Abstract

Application of Chemcatcher® to monitor organotin compounds [monobutyltin (MBT), dibutyltin (DBT) and tributyltin (TBT)] in sea water has been little developed. Prior to the measurement of the time-weighted average water concentrations (TWAC), a calibration step is required to determine sampling rates (Rs) which is usually assessed in a flow-through laboratory pilot where experimental conditions are well controlled. This paper investigates the effect of the water matrix (tap water vs real sea water from the harbor of Port Camargue in France) and organotin concentrations on the uptake rates of organotin compounds. Laboratory calibrations provided sampling rates in the range of 66 – 225 mL.day⁻¹ in high concentration (usually used for laboratory calibrations) and in the range of 30 – 56 mL.day⁻¹ at low concentrations (environmental range). When the tank is filled with real sea water, sampling rates were found to be in the range of 38 – 177 mL.day⁻¹. In order to demonstrate the efficiency of Chemcatcher® in real conditions, in situ calibration was done in the harbor of Port Camargue. This calibration has been done in order to replicate environmental conditions: compounds concentrations, hydrodynamic and water matrix effects. To compare the impact of calibration procedures on TWAC determination, Chemcatcher® was deployed in the harbor of Port Camargue and spot sampling was performed to monitor the concentrations of organotins

in water throughout the exposure period. Results obtained using the field Rs determined by in situ calibration were more reliable. In this case, TWAC is in agreement with spot sampling concentration.

Keywords : Organotin, Marina water, Chemcatcher®, Passive Sampling, Calibration, Sampling rate

Introduction

The organotin compounds monobutyltin (MBT), dibutyltin (DBT) and tributyltin (TBT) have been known for several years to be amongst the most hazardous compounds for both humans and aquatic ecosystems. This is due to their high toxicity, particularly that of tri-substituted organotins (R_3SnX), and above all, tributyltin (TBT). The effects of these compounds in the aquatic environment can be observed at concentrations of less than 1 ng.L^{-1} [1, 2]. Among these effects, the most well documented are the thickening of oyster shells and imposex in gastropods [3-5]. Organotin compounds have teratogenic properties and can cause disruptions to reproductive function in mammals, as well as acting as endocrine disruptors, hepatoxins, immunotoxins, neurotoxins and obeseogens [6-9]. Organotins have been used for years in several activity sectors, but particularly as antifouling paints for boats, namely a biocide to protect the hull. Organotins have been used as stabilizers in PVC, as well as in pesticides and bactericides [9-11]. In 2001, regulations surrounding the use of organotins were put in place, and the use of organotin-based antifouling paints was prohibited by the International Convention on the Control of Harmful Anti-fouling Systems on Ships (AFS Convention Annex 1, 2001) [12]. Organotin compounds are included in the list of priority pollutants of the US Environmental Protection Agency (US-EPA) and the European Commission. In 1999, the US-EPA [13] recommended a maximum of 10 ng.L^{-1} of TBT (as a cation) in seawater and 63 ng.L^{-1} in freshwater. Meanwhile the European Environmental Quality Standard (EQS) of TBT for all types of waters covered by WFD (Water Framework Directive) is 0.2 ng.L^{-1} for annual average concentration, and a maximum allowed concentration of 1.5 ng.L^{-1} in unfiltered water samples

[14]. However, despite these regulations, organotins are still found in the environment due to their stability in sediments. In fact, studies have shown that the half-life of TBT within an aquatic compartment can reach up to more than 10 years, depending on the sediment and water conditions [15]. Measurement of the concentration of these pollutants in the water column is therefore important for assessing their potential long-term biological impact.

As the total concentration of organotin compounds in contaminated water is typically near the ng.L^{-1} level, it is necessary to use large volumes of water and/or a pre-concentration step during analysis to reach the detection limit. In order to monitor levels of organotin in the aquatic environment, both bio-monitoring (measurement of the accumulation of pollutants in the tissues of living organisms) [16, 17] and water sample collection [18] are usually used. However, the latter sampling method measures the concentration of compounds only at the time and point of sampling. This method is unreliable if there are fluctuations within a water compartment over short periods (such as effluent input, tidal cycle). In these cases, it would be necessary to monitor over a longer time period to obtain a time-weighted average water concentration (TWAC) measurement. This information can be obtained using passive sampling devices.

The use of passive sampling techniques as an alternative strategy for monitoring water quality has been gaining interest in recent years [19-22]. Passive sampling devices allow the measurement of compounds in water (and are generally bio-available), and can provide more efficiency in storage, deployment and sensibility. A lot of passive sampling devices are available depending on the pollutant of interest and the matrix sampled. The Polar Organic Chemical Integrative Sampler (POCIS) [23-25] is used to monitor polar ($\log K_{ow} < 3$) hydrophilic organic compounds (pharmaceutical residues, herbicides). The Semi-Permeable Membrane Devices (SPMD) can be used for non-polar ($\log K_{ow} > 3$) organic compound sampling such as PAHs, PCBs and pesticides [16, 26]. Inorganic compounds such as Cu, Cd, Ni, Pb or Zn can be sampled using Diffusion Gradient Thin films (DGT) [27-29]. This sampler has also been reworked to monitor organic compounds like antibiotics or pesticides for which it has been renamed o-DGT [30, 31]. They also have been used for organotin monitoring in coastal sediments [32]. The Chemcatcher® passive sampler device, by contrast, can be deployed to evaluate the time-

weighted average concentration (TWAC) of both organic [33, 34] and inorganic (heavy metal) compounds [35] in the aquatic environment ($1.5 < \log(\text{know}) < 6$). These different types of passive sampling devices allow the monitoring of numerous compounds, however, calibration data such as the sampling rate are not always available. Therefore, field application data are often reported as the amount of pollutant sequestered in the receiving phase, rather than the estimated time-weighted average water concentration (TWAC) obtained with the calibration sampling rate. All passive sampling devices have a receiving phase with a high affinity for the analytes of interest and this phase is separated from the contaminated environment by a diffusion membrane. Contaminants are caught by the receiving phase and accumulated until extraction and analysis. After laboratory calibration of the sampler (using usually a flow-through calibration tank), the TWAC of a pollutant in the water can be calculated thanks to the sampling rate obtained. Passive samplers can be used for short-term (few days) and long-term exposures (several weeks).

However, calibration using the passive sampling method remains controversial. This calibration step is required to calculate a sampling rate value in order to use this sampler as a semi-quantitative tool (Morin et al. 2013; Morin et al. 2012)[36, 37]. Various methods of calibration can be used, ranging from laboratory calibration to field calibration. Laboratory calibrations are conducted under controlled conditions (temperature, flow or velocity, pH and salinity of the water matrix, lack of biofouling) including static with negligible depletion [38, 39], static with renewal [40], static with partition controlled delivery [41], flow through [33, 42] and in artificial streams or channels [43, 44]. Only a few studies were done with in situ calibration of passive samplers compared to laboratory calibrations [45-51].

The choice of calibration depends on the passive sampler used and the compounds studied and can impact the sampling rate calculation, and therefore the ambient concentration estimation. Since calibrations are generally performed in the laboratory with tap or synthetic waters spiked with high concentration levels and without significant fouling, laboratory sampling rates could be different than the effective ones in real environmental conditions. Numerous studies using the Chemcatcher® device were performed in a laboratory. Typically, a calibration tank is used to obtain compounds' sampling rates [52]. Due to the lack of

standardization and numerous methods of calibration, different experiments can result in different sampling rates, depending on turbulence, sampler exposure, homogeneity, duration, concentration, etc. [20, 33, 53]. Another impacting factor is the water matrix used during the calibration process. The compositions, including pH and ionic strength, of tap, sea, river and distilled water are in fact slightly different, and could have an impact on compound sampling. In order to minimize the impact of these differences, two other forms of calibration can be done: in situ calibration, and uptake of PRC (performance and reference compounds). PRC are compounds with the same behavior as analytes that are loaded into the sampler. Monitoring of PRC dissipation from the sampler to the aquatic matrix is then performed to estimate the sampling rate of the targeted contaminant. However, this method is not compatible with all passive samplers and compounds. In fact, the chosen PRC must be able to dissipate from the sampler, which is sometimes difficult to find, particularly for a Chemcatcher® device using C18 disks and POCIS, due to the anisotropic transfer of analytes from the water to the sampler. Furthermore, the dissipation must be fast enough to measure the difference from the beginning of the calibration period to the end. For organotin sampling with Chemcatcher®, for example, the most similar compound is tripropyltin, which is not found in the environment, and is currently used as an internal standard for analytical purposes. But its use as a PRC would contaminate the sampling site and complicate the analysis procedure. As a consequence, for organotin compounds, Chemcatcher® calibrations have only been done in a laboratory with synthetic sea water [20] and no in-situ calibration has been performed with Chemcatcher® devices for organotin monitoring.

The aim of this study was to investigate the effect of the type of Chemcatcher® calibration on the sampling rate of tributyltin (TBT), dibutyltin (DBT) and monobutyltin (MBT) in order to monitor these compounds in harbor areas. Laboratory calibrations were performed to study the influence of the water matrices used in the laboratory pilot, including tap water and real sea water matrices. Then, the influence of concentration levels in the flow-through calibration tank using concentrations closer to environmental levels was also considered. Finally, for the first-time, field calibration was performed in real conditions in an harbor area and compared with laboratory calibration done with water sampled from this harbor.

This study could help to determine the calibration method that is most relevant to the assessment of TWAC in different environmental conditions and the researchers' aim and monitoring objectives.

Experimental

Chemicals and reagents

All solvents and reagents were of analytical grade, or higher, purity. Tributyltin chloride (96%), dibutyltin dichloride (97%), and monobutyltin trichloride (95%) were obtained from Sigma-Aldrich Chimie SARL (Saint-Quentin Fallavier, France) and LGC Promochem (Molsheim, France), and the tripropyltin chloride (98%) from Strem Chemicals (Bischoffshausen, France). Tripropyltin was used as a chromatographic internal standard because it is easily derivatized, and normally absent in polluted water. All standard stock solutions (1000 mg(Sn).L⁻¹) were prepared by dissolving an appropriate amount of each organotin in methanol (HPLC grade, Carlo Erba Reagents, France), and stored in glass bottles at 4°C in the dark. Working solutions of 10 mg(Sn).L⁻¹ and 0.1 mg(Sn).L⁻¹ were prepared by diluting stock solutions in deionized water. Standards were prepared weekly for 10mg(Sn).L⁻¹ standards, and daily for 0.1mg(Sn).L⁻¹ standards, and stored in the dark at 4°C. Samples were kept at 4°C in the dark and acidified to 1/1000 with nitric acid (Honeywell, Germany). Analysis glass vials were also prepared in a 20% solution of nitric acid and rinsed several times with ultrapure Milli-Q water (18.2 MW). For analysis, an aqueous solution of 2% NaBEt₄ (97%, Sigma Aldrich, Germany) in ultrapure water was used as a derivatizing agent, and an acetic-acetate buffer (2mol.L⁻¹, pH 4.8) was used to control the derivatization. This was prepared using sodium acetate (Honeywell, Germany) and acetic acid (Carlo Erba reagents, France). Ethylated derivatives were simultaneously extracted either by iso-octane (For analysis, Carlo Erba, France) for liquid-liquid extraction, or by SPME for liquid-solid extraction, immediately prior to GC-ICP-MS analysis.

Passive sampler design

Receiving phase disks

C18 Empore™ disks (47mm diameter) were obtained from Affinisep (Affinisep, France). The disks were pre-conditioned by overnight soaking in methanol, and rinsed several times with ultrapure water. The disks were not allowed to dry out between pre-conditioning and use. They were found to be free of contamination by the organotin compounds tested in this investigation.

Diffusion membranes

Cellulose Acetate (0.45µm pore size) Whatman™ membranes were from GE Healthcare Life Sciences (Germany). The membranes were rinsed with methanol and water before use. These membranes allowed a pre-selection of accessible compounds, and, specifically, avoided particulate compound sampling.

Chemcatcher® sampler

Sampler bodies containing both the receiving phase and diffusion membrane were made of polytetrafluoroethylene (PTFE). Chemcatcher® is composed of different parts as illustrated in **Figure 1 [33]**. The conditioned receiving phase C18 Empore™ disk (component 4) was placed on the PTFE support (component 1 and 2). The cellulose acetate diffusion membrane (47mm diameter) (component 3) was placed on top of the disk, and care was taken to prevent the formation of air bubbles between the two layers. Once the sampler was assembled, the cavity in front of the diffusion membrane was filled with water and then sealed with a PTFE cap (component 5) and locking ring until use. The PTFE was shown to be free of organotin compound contamination.

Flow-through exposure tank calibration experiments

Chemcatcher® calibration was performed in a homemade flow-through exposure tank similar to those previously described [33]. In brief, it is composed of an exposure tank where passive samplers are exposed on a PTFE carousel. This tank is filled from two other compartments: a matrix water tank (30 mL.min⁻¹) and a stock mixture of organotin (0.3 mL.min⁻¹). Both influents are mixed in a mixing bottle in order to homogenize the concentration before entering the exposure tank. Homogeneity is also ensured by stirring the carousel, which holds

the sampler at 60 rpm (so 119 cm.s⁻¹). For this study, two types of water were used; sea water from the harbor of Port Camargue in France, and tap water. Both 400 ng(Sn).L⁻¹ and 10 ng(Sn).L⁻¹ organotin mixtures were tested. Chemcatcher® devices have previously been used for organotin measurements at 400 ng.L⁻¹ and were deployed for two weeks [20]. In this investigation, measurements were taken at 10 ng.L⁻¹ as this is closer to environmental concentration. During the calibration period, the Chemcatcher® is taken off the tank every two days and the exposure matrix and organotin mixture are sampled for analysis. Sea water from the tank and the water sampling is filtered before analysis in order to avoid particulate organotins. After acidification (nitric acid 1‰), water samples were stored in the fridge at 4°C until analysis. Disks were taken from the Chemcatcher®, dried and stored at -18°C until extraction and analysis.

Flow-through calibration tank validation

Chemcatcher® calibrations were carried out according to Aguilar-Martínez *et al.* 2008's instructions [20] to compare the sampling rate obtained in this study and to validate the flow-through calibration tank. Samplers were exposed for 14 days in the flow-through calibration tank with a exposure concentration higher than the environmental concentration (approximately 400 ng.L⁻¹). The sampling rates obtained were 225 ± 16, 116 ± 7 and 66 ± 1 mL.day⁻¹ for MBT, DBT and TBT respectively. These results show that the calibration pilot is reproducible and comparable to those obtained by Aguilar-Martínez *et al.* for MBT, DBT and TBT (202, 204 and 18 mL.day⁻¹ respectively)[20]. The sampling rates obtained in this study are in the same order of magnitude as those described by Aguilar-Martínez *et al.*, which were measured at 18°C and with a stirring speed of 70 rpm (139 cm.s⁻¹). The differences observed, particularly for the DBT, which shows with a variability of 100 ml.day⁻¹ compared to Aguilar-Martínez *et al.*'s results, might be attributed to differences in concentration in the exposure tank (400ng.L⁻¹) and the stirring speed, which was slower than in our study (119 cm.s⁻¹).

In situ calibration

In order to recreate environmental conditions, in situ calibration needs to be performed. This consists of calibration in a constant organotin concentration in a contaminated area (Port Camargue marina). Chemcatcher® devices are exposed for two weeks, similar to the flow-through exposure tank. They are extracted every two days and the sea water is sampled. Port Camargue in France, the largest European marina with more than 5000 moorings for 60 ha of basin area, was selected for this study. The technical zone features 20 enterprises specialized in leisure vessel maintenance in an area of 4.5 ha, and the zone receives about 2000 vessels each year for careenage operations. Port Camargue receives input from runoff of a very small (200 ha), densely urbanized, drainage basin, as well as from the sea. The study area chosen was in the technical zone of the harbor of Port Camargue. This area has been found to be the most contaminated section of the harbor, and water exhibits a relatively stable organotin concentration. The exposure spot was located between the two technical docks where boats are launched and removed from the water. A previous study showed significant concentrations of organotins in that spot, probably due to the launching of freshly painted boats from those docks. However, the flow velocity in this area is very low (around 30 mm.s⁻¹), so the in situ calibration is done in virtually static environment compared to a laboratory calibration with mechanically-induced flow.

Extraction of organotin compounds from the receiving phase, derivatization procedure and

Instrumental conditions

Following the 14 days exposure, Empore™ disks are extracted from the Chemcatcher® device for analysis in order to measure the mass of organotin accumulated in the sampler. The first step of disk analysis is the extraction of organotins from the solid phase with a well-balanced polarity solvent. Namely, a 12 mL of a mixture of methanol/acetic acid 1:3 was used, coupled with 15 min of ultrasound exposure [20]. The extract is then prepared for analysis.

Butyltin species (MBT, DBT and TBT) were determined using a gas chromatograph (Focus GC Thermo Fisher Scientific®), along with an inductively coupled plasma mass spectrometer (ICP-MS X Series II-Thermo Fisher Scientific®)[54]. This analysis method requires an organotin derivatization step in order to increase its volatility for the gas chromatography step, and

consequently improve the analysis efficiency. This derivatization step is done with NaBEt₄, which exchanges butyl groups with analytes to make them more volatile.

Liquid injection is used for the analysis of extracted organotin and a liquid-liquid extraction is performed in 50 mL glass vials with an acetate buffer (20mL, 2mol.L⁻¹, pH 4.8), extracted acid solution (500 μL), ammonia (500 μL, to counter extract acidity), sodium tetraethylborate (500 μL, 2%), a standard solution of TPrT (used as an internal standard), and isooctane as the extraction solvent (2mL), and shaken for 15 minutes at 300 rpm on an agitation plate. Supernatant isooctane is then transferred into brown vials for analysis. Concentrations are obtained using the standard addition method.

Water samples were analyzed using SPME preconcentration and injection, and were prepared in 10 mL brown vials with acetate buffer (0,5 mL, 2M at pH 4.8), sample (5 mL), sodium tetraethylborate (0.5 mL, 2%), a standard solution of TPrT (used as an internal standard) and shaken for 15 minutes at 300 rpm on an agitation plate. The organotin-derived species were sampled from the headspace using a polydimethylsiloxane (PDMS) (Bellefonte®, USA) fiber. After sampling, the fiber was retracted into the needle of the holder. The SPME fiber was then inserted into the GC injector, where the organotin compounds were thermally desorbed for 1.5 min, enabling complete desorption of all the organotins adsorbed on the fiber [55]. This method was validated using certified reference materials analysis (CRM PACS-2 and PACS-3).

Sampling rate calculation

Uptake of analytes in a passive sampling device can be divided into three steps: the first is a linear uptake kinetic, the second is curvilinear, and the third is an equilibrium state, which in theory is not reached during the deployment. During the first part of the accumulation period, also called the integrative regime, the contaminant accumulation rate is approximately linear, meaning that their mass in the receiving phase is dependent on the concentration of the water sampled and the exposure time, according to the following relationship:

$$M_s = C_w \times R_s \times t \text{ (equation 1)}$$

Where M_s is the mass (ng) of analytes accumulated in the receiving phase, C_w the mean water concentration (ng.L⁻¹), R_s the sampling rate of the device (L.day⁻¹), and t is the exposure time (days). The sampling rate (R_s) is specific for each compound (depending on their affinity in the receiving phase) and corresponds to the amount of water sampled per day. Usually, the initial quantity of compounds in the receiving phase is zero or negligible, and the latter passive sampling rate can be determined with the following relationship:

$$R_s = M_s / C_w \times t \text{ (equation 2)}$$

Time-weighted averaged concentrations (TWAC)

Time-weighted averaged concentrations (TWAC) in natural water were calculated with the following equation adapted from Miège *et al.* 2013 [56] proposition:

$$C_{TWA} = C_{Chem} \times M_{Chem} / R_s \times t \text{ (equation 3)}$$

where C_{TWA} is the mean concentration of the contaminant (over the sampling period-TWAC) in the natural water during the deployment period ($\mu\text{g L}^{-1}$); C_{Chem} is the concentration in the Chemcatcher® ($\mu\text{g g}^{-1}$); M_{Chem} is the mass of adsorbent phase in the Chemcatcher® (g); R_s is the sampling rate (L day⁻¹), which corresponds to the volume of water purified per unit of time; and t is the total exposure time (days).

Results and discussion

Uptake rates of organotin compounds in flow-through calibration tank calibration studies

Influence of environmental concentration

In order to determine the TWAC of organotins in aquatic environments, it is necessary to first determine the sampling rate R_s (measured as mL.day⁻¹). The accumulation rate depends principally on the temperature, turbulence, and biofouling on the sampler. Diffusion is generally affected by the boundary water layer, the biofilm and the diffusion membrane. Two concentration levels were tested through tank calibration: high (about 400ng(Sn).L⁻¹) and low (about 10 ng(Sn).L⁻¹), in order to assess the influence of concentration levels on the accumulation rate.

The high concentration pilot was carried out according to Aguilar-Martínez *et al.* 2008's setup [20]. In this experiment, samplers were exposed for 14 days in a flow-through calibration tank to an organotin mixture of 259 ± 58 ng(Sn).L⁻¹ MBT, 528 ± 59 ng(Sn).L⁻¹ DBT and 715 ± 63 ng(Sn).L⁻¹ TBT in tap water. These concentrations were tracked throughout the experiment by spot sampling. The levels of analytes accumulated in the receiving disk were subsequently measured. Satisfactory linear regressions were obtained (**Figure 2-a**), and allowed the determination of sampling rates for each compound.

During these experiments, all physicochemical parameters were found to be relatively stable (pH=7.9 \pm 0.1, conductivity of 671 ± 36 μ S/cm, Salinity of 0.30 ± 0.02 ‰, dissolved oxygen concentration of 9.1 ± 0.1 mgO₂.L⁻¹, temperature of 19.3 ± 0.4 °C, stirring speed of 60 rpm). The sampling rates obtained were 225 ± 16 , 116 ± 7 and 66 ± 1 mL.day⁻¹ for MBT, DBT and TBT respectively. The coefficient of variation for each sampling rate was determined using concentration variations measured in the flow-through tank.

A similar pilot was carried out using low concentrations (35 ± 9 , 12 ± 1 and 18 ± 3 ng.L⁻¹ of MBT, DBT and TBT respectively), so as to simulate the observed environmental contaminations, and to characterize the effect of low concentrations on the sampling rate. Physico-chemical parameters were also stable throughout the experiment (pH=7.84 \pm 0.02, conductivity of 463 ± 64 μ S/cm, Salinity of 0.25 ± 0.01 ‰, dissolved oxygen concentration of 9.00 ± 0.13 mgO₂.L⁻¹, temperature of 19.5 ± 0.7 °C, stirring speed of 60 rpm). The sampling rates for this calibration were 30 ± 3 , 56 ± 3 and 38 ± 7 mL.day⁻¹ for MBT, DBT and TBT (**Figure 2-b**). Interestingly, sampling rates obtained with low concentration calibrations were up to two times lower than those obtained in high concentration calibrations (**Figure 3**). These results show that the calibration of Chemcatcher® in highly contaminated tap water could give an overestimated sampling rate, if used for environmental purposes (where concentrations are typically lower). TWAC values obtained with these sampling rates could consequently underestimate the concentrations present in natural water. This could be explained by the fact that concentrations in bulk water are so low that the diffusion of compounds from the water to the water boundary layer is affected. In fact, current models consider that compound uptake depends on different diffusion steps through the water boundary layer, the biofilm, and the diffusion membranes,

before reaching the receiving phase. Fick's first law can be used to better understand this result, as explained by Kees Booij and collaborators [57]; mass transfer of analytes is determined by equation (4) where J ($\text{ng}\cdot\text{m}^{-2}\cdot\text{s}^{-1}$) is the flux of matter (analytes), k_i is a mass transfer coefficient ($\text{m}\cdot\text{s}^{-1}$) in a phase i and ΔC_i ($\text{ng}\cdot\text{m}^{-3}$) is the gradient of concentration in this phase (equation 4). Furthermore, k_i is only dependent on the diffusion constant of the component D_i ($\text{m}^2\cdot\text{s}^{-1}$), and the thickness of the phase considered δ_i (m) as shown in equation (5). As the two experiments were done in similar conditions (temperature, turbulence, sampler etc.) the only variable is the concentration. Therefore, this transfer coefficient should be consistent between experiments, and so the gradient of concentration (lower at low concentrations) has an impact on the mass transfer flux.

$$J_i = k_i(\Delta C_i) \quad (\text{equation 4})$$

$$k_i = D_i / \delta_i \quad (\text{equation 5})$$

Aguilar-Martínez *et al.* [20] reported a TWAC value measured in sea water (harbour of Alicante) with Chemcatcher® that was lower than the value found in spot sampling. As the water samples were unfiltered, the concentrations measured included the organotin in suspended matter. As the calibration of the Chemcatcher® was carried out in highly concentrated tap water ($400\text{ng}\cdot\text{L}^{-1}$), the sampling rates could have been overestimated.

Influence of the water matrix

Sampling rate estimations are often carried out in tap water, even for environmental use. In order to evaluate the potential influence of the environmental water matrix on the sampling rate, Chemcatcher® were deployed in calibration tanks filled with unfiltered sea water sampled from the harbor of Port Camargue in France, spiked with organotins up to $10\text{ng}\cdot\text{L}^{-1}$ (10 ± 3 , 17 ± 3 , 5 ± 1 $\text{ng}\cdot\text{L}^{-1}$ for MBT, DBT and TBT respectively). Similarly to the previous calibrations, water concentration was tracked by spot sampling, and the receiving disks were extracted after 14 days. Physico-chemical parameters remained stable (pH= 8.0 ± 0.1 , conductivity of 50.2 ± 1.3 $\mu\text{S}/\text{cm}$, salinity of 33 ± 1 ‰, dissolved oxygen concentration of 9.3 ± 0.1 $\text{mgO}_2\cdot\text{L}^{-1}$, temperature of 19.7 ± 0.1 °C, stirring speed of 60 rpm), and linearization of accumulated mass in each disk

allowed the determination of the sampling rate in the water matrix. **Figure 4** presents the sampling rate obtained in tap water and sea water (38 ± 10 , 103 ± 2 , 177 ± 52 mL.day⁻¹ for MBT, DBT and TBT respectively). The sampling rates measured with sea water calibration were higher than those with tap water calibration. With the exception of MBT, sampling rate in sea water reached levels of two times higher or more those determined using tap water. This could be explained by the relative affinity of analytes for the water. In fact, salinity was found to be around 33‰ in sea water and 0.3 ‰ in tap water. Ionic strength could consequently have an impact on the diffusion of compounds to the sampler. Notably, the behavior of compounds can be impacted by the ionic strength [58]. Furthermore, it has been observed that the formation of biofilm on the sampler accumulation surface was faster in sea water. The accumulation rate in sea water might be higher without this biofilm. Finally, the water matrix used in flow-through tank calibrations has an impact on the sampling rate estimation as well. Ideally, for field trials in sea water environment or estuaries, tank calibrations should be performed in a sea water matrix to improve the reliability of the sampling rate.

In situ calibration

The tank calibration results seem to highlight the effects of the matrix and concentration on the sampling rate estimation. An in-situ calibration was therefore carried out in Port Camargue's harbor in France and compared with the calibration tank results (R_s lab/ R_s in situ). Chemcatcher® were deployed in the technical zone of Port Camargue's harbour, that was found, using spot sampling, to be the most contaminated area of the harbor (7 ± 2 , 11 ± 3 and $0,3 \pm 0.1$ ng.L⁻¹ for MBT, DBT and TBT respectively). Concentration monitoring demonstrated that organotin concentration remained stable during the Chemcatcher® exposure period (**Figure 6**). Intriguingly, the mass accumulated by the Chemcatcher® device was very low (**Figure 5**), up to 1.2 ng, compared to 10 to 100 ng in flow-through tank calibrations. This could again be attributed to the natural environmental conditions, where the water velocity does not exceed 30 mm.s⁻¹ when, for laboratory calibration, the water velocity was set at 60 rpm (equivalent to 1190 mm.s⁻¹), which almost 40 times higher than in the harbor. The uptake line measured a sampling rate of 7 ± 2 , 4 ± 1 and 140 ± 52 mL.day⁻¹ for the MBT, DBT and TBT. However, the result

obtained for the TBT has a correlation coefficient of 0.67, and this result is not sufficiently reliable. Nevertheless, it seems that the sampling rates in situ are significantly lower than those determined during laboratory calibrations. Furthermore, the amount of compounds sequestered is still extremely low due to the low water velocity in the harbour.

Impact of calibration procedures on TWAC determination

In order to compare efficiency of each calibration method and consequently sampling rates, samplers were exposed for 10 days in the Port Camargue's harbour next to its technical zone and spot sampling was performed throughout the experimental period (**Figure 6**).

TWAC values were obtained for each calibration procedures (experimental sampling rates), and compared to spot sampling concentrations (**Figure 7**).

Some studies assessed the uncertainty of the TWAC measurements in natural water obtained with a Polar Organic Chemical Integrative Sampler (POCIS) [59]. In this case, the uncertainty (U_{sampler}) can be measured for each compound, with the RSD corresponding to the repeatability's relative standard deviation, and C_{sampler} to the concentration determined with the sampler, as follows:

$$0.5 \times C_{\text{sampler}} - 2RSD_i \times C_{\text{sampler}} \leq U_{\text{sampler}} \leq 2 \times C_{\text{sampler}} + 2RSD_i \times C_{\text{sampler}}$$

This study, however, lacks sufficient technical replicates to calculate the RSD.

Figure 7 highlights the differences between the sampling rate obtained for the different calibration methods ($R_{\text{s lab}}/R_{\text{s in-situ}}$) and the calculated TWAC. As expected, the laboratory calibration provides a different concentration to spot sampling, for both MBT and DBT, particularly in the high concentration flow-through exposure tank. For TBT, calibrations at low concentration can be used but may introduce uncertainty (lower linearity coefficient). Pilots at low concentrations seem to provide concentration levels closer to those obtained during spot sampling compared to high concentration pilots. The use of real sea water during the calibration step at low concentrations does not generate more reliable concentration measurements. Nevertheless, in situ calibration appears sufficiently reliable to determine the environmental concentration. To generalize this in situ calibration approach, it will be necessary

to find areas with stable organotin concentration, and repeat measurements for each area studied to improve R reliability.

Conclusion

This study highlights the impact of calibration on the sampling rate of organotin compounds and consequently on TWAC measurements. Environmental concentrations of analytes in the pilot impacted the sampling rate compared to the high concentrations typically used in a laboratory. Further experimentation will be required to elucidate this phenomenon. For example, accumulation factors and kinetics could be quantified to monitor concentration levels during the accumulation period. This work also highlighted the impact of the water matrix on the sampling rate. Sea water provides higher sampling rates compared to tap water. Finally, in situ calibration leads to more reproducible and therefore reliable results, closer to reality, and should be applied whenever possible. Furthermore, the relatively low concentrations and flow velocity in natural conditions compared to laboratory conditions can introduce more variability (or uncertainty). Chemcatcher® devices represent a useful tool for monitoring organotin compounds found at low concentration in the environment and water quality.

Acknowledgements

We acknowledge the financial support of the Occitanie region (80%) and of the École des Mines d'Alès (20%) (ALDOCT-000140) for this work realized in collaboration with the Laboratoire de Génie de l'Environnement Industriel of Alès (LGEI) and HydroSciences Montpellier (HSM).

References

- [1] J.P. Meador, C.A. Krone, D.W. Dyer, U. Varanasi, Toxicity of sediment-associated tributyltin to infaunal invertebrates: Species comparison and the role of organic carbon, *Marine Environmental Research* 43(3) (1997) 219-241.
- [2] C. Alzieu, Environmental impact of TBT: the French experience, *The Science of the total environment* 258(1-2) (2000) 99-102.
- [3] C.L. Alzieu, J. Sanjuan, J.P. Deltreil, M. Borel, Tin contamination in Arcachon Bay: Effects on oyster shell anomalies, *Marine Pollution Bulletin* 17(11) (1986) 494-498.
- [4] P. E. Gibbs, G. W. Bryan, Reproductive Failure in Populations of the Dog-Whelk, *Nucella Lapillus*, Caused by Imposex Induced by Tributyltin from Antifouling Paints, 1986.
- [5] G. Bryan, P. Gibbs, Impact of low concentrations of tributyltin (tbt) on marine organisms: a review, Newman MC, McIntosh AW (eds.) *Metal ecotoxicology : concepts and applications*. (1991) 323-361.
- [6] Z. Zuo, S. Chen, T. Wu, J. Zhang, Y. Su, Y. Chen, C. Wang, Tributyltin causes obesity and hepatic steatosis in male mice, *Environ Toxicol* 26(1) (2011) 79-85.
- [7] J.B. Graceli, G.C. Sena, P.F.I. Lopes, G.C. Zamprogno, M.B. da Costa, A.F.L. Godoi, D.M. dos Santos, M.R.R. de Marchi, M.A. dos Santos Fernandez, Organotins: A review of their reproductive toxicity, biochemistry, and environmental fate, *Reproductive Toxicology* 36(Supplement C) (2013) 40-52.
- [8] A.C.A. Sousa, M.R. Pastorinho, S. Takahashi, S. Tanabe, Organotin Compounds from Snails to Humans, in: E. Lichtfouse, J. Schwarzbauer, D. Robert (Eds.), *Pollutant Diseases, Remediation and Recycling*, Springer International Publishing, Cham, 2013, pp. 215-275.
- [9] A.C.A. Sousa, S. Tanabe, M.R. Pastorinho, Organotins: Sources and Impacts on Health and Environment A2 - Dellasala, Dominick A, in: M.I. Goldstein (Ed.), *Encyclopedia of the Anthropocene*, Elsevier, Oxford, 2017, pp. 133-139.
- [10] M. Hoch, Organotin compounds in the environment — an overview, *Applied Geochemistry* 16(7) (2001) 719-743.
- [11] T.W.H. Organisation, Mono- and disubstituted methyltin, butyltin, and octyltin compounds, *Concise International Chemical Assessment Document* 73 (2006).
- [12] I.M. Organization, *International Convention on the Control of Harmful Anti-fouling Systems on Ships*, (2001).
- [13] U.S.E.P. Agency, *National Recommended Water Quality Criteria*, Office of Water 4304 EPA 822-Z-99-001 (1999).
- [14] W.F. Directive, *Directive on Environmental Quality Standards (2000/60/EC, 2008/105/EC)*.
- [15] W.J. Langston, N.D. Pope, M. Davey, K.M. Langston, S.C.M. O' Hara, P.E. Gibbs, P.L. Pascoe, Recovery from TBT pollution in English Channel environments: A problem solved?, *Marine Pollution Bulletin* 95(2) (2015) 551-564.
- [16] N. Folsvik, E.M. Brevik, J.A. Berge, Organotin compounds in a Norwegian fjord. A comparison of concentration levels in semipermeable membrane devices (SPMDs), blue mussels (*Mytilus edulis*) and water samples, *Journal of environmental monitoring : JEM* 4(2) (2002) 280-3.
- [17] W.C.K. De Kock, K. J. M., Active biomonitoring (ABM) by translocation of bivalve molluscs. In *Biomonitoring of Coastal Waters and Estuaries* (K. J. M. Kramer, ed.) CRC Press Inc., Boca Raton, USA, (1994) 51.
- [18] P. Rodríguez-González, J. Ruiz Encinar, J.I. García Alonso, A. Sanz-Medel, Determination of butyltin compounds in coastal sea-water samples using isotope dilution GC-ICP-MS, *Journal of Analytical Atomic Spectrometry* 17(8) (2002) 824-830.
- [19] R.F. Cole, G.A. Mills, R. Parker, T. Bolam, A. Birchenough, S. Kröger, G.R. Fones, Trends in the analysis and monitoring of organotins in the aquatic environment, *Trends in Environmental Analytical Chemistry* 8(Supplement C) (2015) 1-11.
- [20] R. Aguilar-Martínez, M.A. Palacios-Corvillo, R. Greenwood, G.A. Mills, B. Vrana, M.M. Gómez-Gómez, Calibration and use of the Chemcatcher® passive sampler for monitoring organotin compounds in water, *Analytica Chimica Acta* 618(2) (2008) 157-167.
- [21] R. Greenwood, G.A. Mills, B. Vrana, I. Allan, R. Aguilar-Martínez, G. Morrison, Chapter 9 Monitoring of priority pollutants in water using chemcatcher passive sampling devices, in: R. Greenwood, G. Mills, B. Vrana (Eds.), *Comprehensive Analytical Chemistry*, Elsevier 2007, pp. 199-229.
- [22] A. Charriau, S. Lissalde, G. Poulhier, N. Mazzella, R. Buzier, G. Guibaud, Overview of the Chemcatcher(R) for the passive sampling of various pollutants in aquatic environments Part A: Principles, calibration, preparation and analysis of the sampler, *Talanta* 148 (2016) 556-71.
- [23] P. Branchet, E. Cadot, D. Sebag, H. Fenet, B.N. Ngatcha, C. Gonzalez, POCIS evidence Yaoundé's rivers pesticides contamination, *Goldschmidt 2017*, Paris, France, 2017.
- [24] I. Ibrahim, Study of the applicability of passive samplers POCIS and Chemcatcher for monitoring pesticides in aquatic systems, *Ecole Nationale Supérieure des Mines de Saint-Etienne*, 2013.
- [25] D.A. Alvarez, J.D. Petty, J.N. Huckins, T.L. Jones-Lepp, D.T. Getting, J.P. Goddard, S.E. Manahan, Development of a passive, in situ, integrative sampler for hydrophilic organic contaminants in aquatic environments, *Environ Toxicol Chem* 23(7) (2004) 1640-8.
- [26] J.N. Huckins, G.K. Manuweera, J.D. Petty, D. Mackay, J.A. Lebo, Lipid-containing semipermeable membrane devices for monitoring organic contaminants in water, *Environmental Science & Technology* 27(12) (1993) 2489-2496.
- [27] R. Guibal, R. Buzier, A. Charriau, S. Lissalde, G. Guibaud, Passive sampling of anionic pesticides using the Diffusive Gradients in Thin films technique (DGT), 2017.
- [28] C. Casiot, M. Egal, F. Elbaz-Poulichet, O. Bruneel, C. Bancon-Montigny, M.-A. Cordier, E. Gomez, C. Aliaume, Hydrological and geochemical control of metals and arsenic in a Mediterranean river contaminated by acid mine drainage (the Amous River, France); preliminary assessment of impacts on fish (*Leuciscus cephalus*), *Applied Geochemistry* 24(5) (2009) 787-799.
- [29] W. Davison, H. Zhang, K.W. Warnken, Chapter 16 Theory and applications of DGT measurements in soils and sediments, in: R. Greenwood, G. Mills, B. Vrana (Eds.), *Comprehensive Analytical Chemistry*, Elsevier 2007, pp. 353-378.
- [30] C.E. Chen, W. Chen, G.G. Ying, K.C. Jones, H. Zhang, In situ measurement of solution concentrations and fluxes of sulfonamides and trimethoprim antibiotics in soils using o-DGT, *Talanta* 132 (2015) 902-908.
- [31] R. Guibal, R. Buzier, S. Lissalde, G. Guibaud, Adaptation of diffusive gradients in thin films technique to sample organic pollutants in the environment: An overview of o-DGT passive samplers, *Science of the Total Environment* 693 (2019) 12.

- [32] R.F. Cole, G.A. Mills, M.S. Hale, R. Parker, T. Bolam, P.R. Teasdale, W.W. Bennett, G.R. Fones, Development and evaluation of a new diffusive gradients in thin-films technique for measuring organotin compounds in coastal sediment pore water, *Talanta* 178(Supplement C) (2018) 670-678.
- [33] B. Vrana, G.A. Mills, E. Dominiak, R. Greenwood, Calibration of the Chemcatcher passive sampler for the monitoring of priority organic pollutants in water, *Environmental Pollution* 142(2) (2006) 333-343.
- [34] J.K. Kingston, R. Greenwood, G.A. Mills, G.M. Morrison, L.B. Persson, Development of a novel passive sampling system for the time-averaged measurement of a range of organic pollutants in aquatic environments, *Journal of environmental monitoring : JEM* 2(5) (2000) 487-95.
- [35] L.B. Persson, G.M. Morrison, J.-U. Friemann, J. Kingston, G. Mills, R. Greenwood, Diffusional behaviour of metals in a passive sampling system for monitoring aquatic pollution, *J. Environ. Monit.* 3(6) (2001) 639-645.
- [36] N. Morin, C. Miège, M. Coquery, J. Randon, Chemical calibration, performance, validation and applications of the polar organic chemical integrative sampler (POCIS) in aquatic environments, *TrAC Trends in Analytical Chemistry* 36 (2012) 144-175.
- [37] N. Morin, J. Camilleri, C. Cren-Olive, M. Coquery, C. Miegé, Determination of uptake kinetics and sampling rates for 56 organic micropollutants using "pharmaceutical" POCIS, *Talanta* 109 (2013) 61-73.
- [38] M. Shaw, G. Eaglesham, J.F. Mueller, Uptake and release of polar compounds in SDB-RPS Empore disks; implications for their use as passive samplers, *Chemosphere* 75(1) (2009) 1-7.
- [39] D. O'Brien, M. Bartkow, J.F. Mueller, Determination of deployment specific chemical uptake rates for SDB-RPD Empore disk using a passive flow monitor (PFM), *Chemosphere* 83(9) (2011) 1290-1295.
- [40] S.L. Kaserzon, D.W. Hawker, K. Kennedy, M. Bartkow, S. Carter, K. Booij, J.F. Mueller, Characterisation and comparison of the uptake of ionizable and polar pesticides, pharmaceuticals and personal care products by POCIS and Chemcatchers, *Environmental Science: Processes & Impacts* 16(11) (2014) 2517-2526.
- [41] R. Jacquet, C. Miège, F. Smedes, C. Tixier, J. Tronczynski, A. Togola, C. Berho, I. Valor, J. Llorca, B. Barillon, P. Marchand, M. Coquery, Comparison of five integrative samplers in laboratory for the monitoring of indicator and dioxin-like polychlorinated biphenyls in water, *Chemosphere* 98 (2014) 18-27.
- [42] J. Camilleri, N. Morin, C. Miège, M. Coquery, C. Cren-Olivé, Determination of the uptake and release rates of multifamilies of endocrine disruptor compounds on the polar C18 Chemcatcher. Three potential performance reference compounds to monitor polar pollutants in surface water by integrative sampling, *Journal of chromatography. A* 1237 (2012) 37-45.
- [43] R.B. Schafer, A. Paschke, B. Vrana, R. Mueller, M. Liess, Performance of the Chemcatcher passive sampler when used to monitor 10 polar and semi-polar pesticides in 16 Central European streams, and comparison with two other sampling methods, *Water Res* 42(10-11) (2008) 2707-17.
- [44] E.L.M. Vermeirssen, J. Asmin, B.I. Escher, J.-H. Kwon, I. Steimen, J. Hollender, The role of hydrodynamics, matrix and sampling duration in passive sampling of polar compounds with Empore[trade mark sign] SDB-RPS disks, *J. Environ. Monit.* 10(1) (2008) 119-128.
- [45] S. Aguerre, G. Lespes, M. Potin-Gautier, Physico-chemical approach to study organotin sorption-desorption during solid-phase microextraction, *Journal of Chromatography A* 999(1) (2003) 61-70.
- [46] C. Harman, M. Reid, K.V. Thomas, In Situ Calibration of a Passive Sampling Device for Selected Illicit Drugs and Their Metabolites in Wastewater, And Subsequent Year-Long Assessment of Community Drug Usage, *Environmental Science & Technology* 45(13) (2011) 5676-5682.
- [47] R. Jacquet, C. Miège, P. Bados, S. Schiavone, M. Coquery, Evaluating the polar organic chemical integrative sampler for the monitoring of beta-blockers and hormones in wastewater treatment plant effluents and receiving surface waters, *Environ Toxicol Chem* 31(2) (2012) 279-88.
- [48] C. Moschet, E.L.M. Vermeirssen, H. Singer, C. Stamm, J. Hollender, Evaluation of in-situ calibration of Chemcatcher passive samplers for 322 micropollutants in agricultural and urban affected rivers, *Water Research* 71 (2015) 306-317.
- [49] B. Petrie, A. Gravell, G.A. Mills, J. Youdan, R. Barden, B. Kasprzyk-Hordern, In Situ Calibration of a New Chemcatcher Configuration for the Determination of Polar Organic Micropollutants in Wastewater Effluent, *Environ Sci Technol* 50(17) (2016) 9469-78.
- [50] Z. Zhang, A. Hibberd, J.L. Zhou, Analysis of emerging contaminants in sewage effluent and river water: Comparison between spot and passive sampling, *Analytica Chimica Acta* 607(1) (2008) 37-44.
- [51] I. Ibrahim, A. Togola, C. Gonzalez, In-situ calibration of POCIS for the sampling of polar pesticides and metabolites in surface water, *Talanta* 116 (2013) 495-500.
- [52] S. Lissalde, A. Charriau, G. Poulier, N. Mazzella, R. Buzier, G. Guibaud, Overview of the Chemcatcher® for the passive sampling of various pollutants in aquatic environments Part B: Field handling and environmental applications for the monitoring of pollutants and their biological effects, *Talanta* 148(Supplement C) (2016) 572-582.
- [53] A. de la Cal, M. Kuster, M.L. de Alda, E. Eljarrat, D. Barceló, Evaluation of the aquatic passive sampler Chemcatcher for the monitoring of highly hydrophobic compounds in water, *Talanta* 76(2) (2008) 327-332.
- [54] N. Briant, C. Bancon-Montigny, R. Freydier, S. Delpoux, F. Elbaz-Poulichet, Behaviour of butyltin compounds in the sediment pore waters of a contaminated marina (Port Camargue, South of France), *Chemosphere* 150 (2016) 123-129.
- [55] C. Bancon-Montigny, G. Lespes, M. Potin-Gautier, Optimisation of the storage of natural freshwaters before organotin speciation, *Water Research* 35(1) (2001) 224-232.
- [56] C. Miegé, H. Budzinski, R. Jacquet, C. Soulier, T. Pelte, M. Coquery, Polar organic chemical integrative sampler (POCIS): application for monitoring organic micropollutants in wastewater effluent and surface water, *Journal of environmental monitoring : JEM* 14(2) (2012) 626-35.
- [57] K. Booij, B. Vrana, J.N. Huckins, Chapter 7 Theory, modelling and calibration of passive samplers used in water monitoring, in: R. Greenwood, G. Mills, B. Vrana (Eds.), *Comprehensive Analytical Chemistry*, Elsevier 2007, pp. 141-169.

- [58] M. Bueno, A. Astruc, J. Lambert, M. Astruc, P. Behra, Effect of solid surface composition on the migration of tributyltin in groundwater, *Environmental Science and Technology* 35(7) (2001) 1411-1419.
- [59] G. Poulhier, S. Lissalde, A. Charriau, R. Buzier, F. Delmas, K. Gery, A. Moreira, G. Guibaud, N. Mazzella, Can POCIS be used in Water Framework Directive (2000/60/EC) monitoring networks? A study focusing on pesticides in a French agricultural watershed, *Science of The Total Environment* 497-498 (2014) 282-292.

Figure 1 : Schematic diagram of the Chemcatcher sampling device

Figure 2 : Uptake regression of tributyltin (TBT), dibutyltin (DBT) and monobutyltin (MBT) for the Chemcatcher® deployed in a flow-through calibration tank. Water temperature 17 °C and carousel rotation speed 60 rpm. Nominal concentration of each compound was respectively 259, 528 and 715 ngL⁻¹ (Figure a) and 35, 12 and 18 ng.L⁻¹ (Figure b).

Figure 3 : Effect of organotin's concentration in calibration tank on the sampling rate estimation. Water temperature 19.3 °C and 19.5°C and carousel rotation speed 60 rpm. Nominal concentrations of each compound were respectively 715, 527 and 260 ngL⁻¹ and 35, 12 and 18ng.L⁻¹.

Figure 4 : Effect of matrix on the sampling rate estimation. Water temperature 19.5 °C and 19.4°C and carousel rotation speed 60 rpm. Nominal concentrations of each compound were respectively 35, 12, 18ng.L⁻¹ and 10, 17, 5ng.L⁻¹.

Figure 5 : In-situ calibration uptake of organotins in Chemcatcher. Calibration done in the technical zone of the harbor of Port Camargue in France.

Figure 6 : Spot sampling concentration measurement throughout Chemcatcher exposure in the technical area of the harbor of Port Camargue.

Figure 7: Time weighted average concentration comparison using laboratory and in-situ determined sampling rates and the average spot sampling concentration during 14 days of exposure

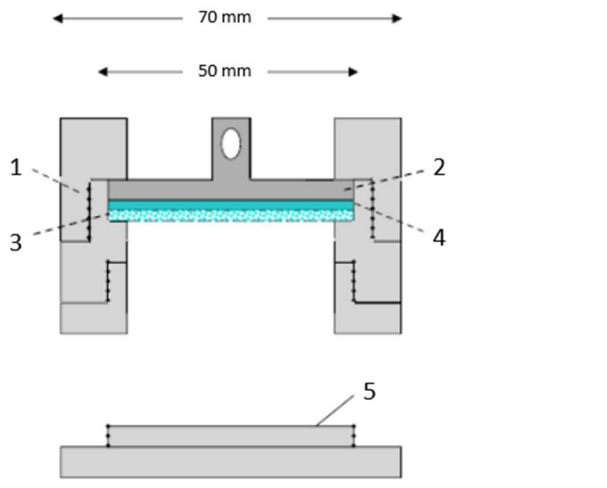

1.

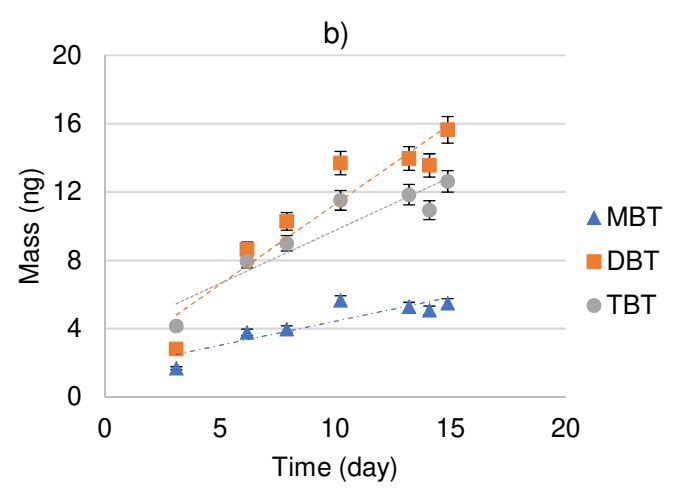
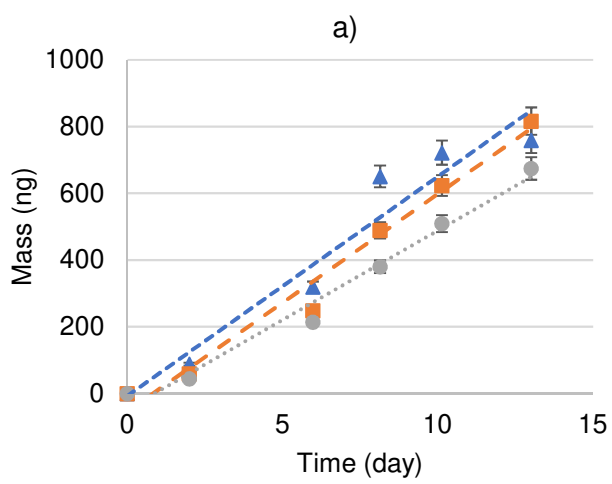

2.

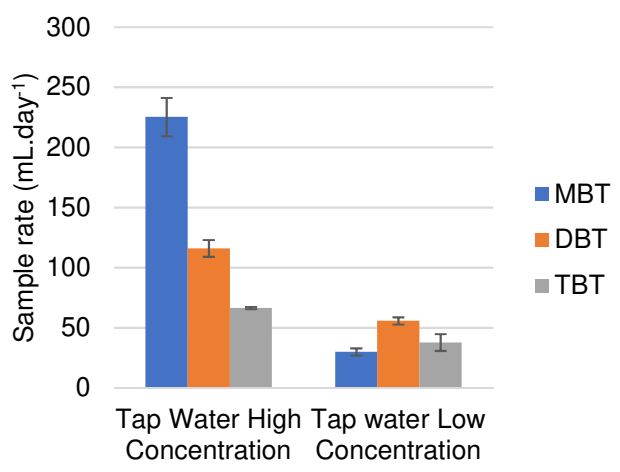

3.

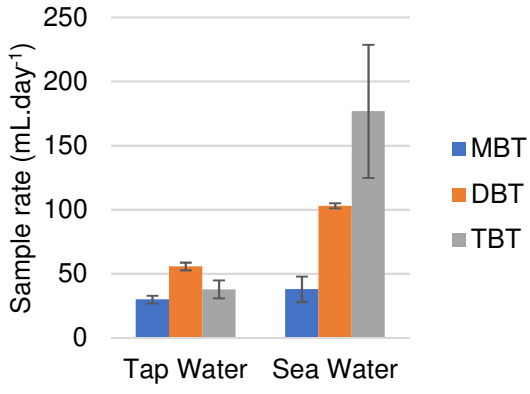

4.

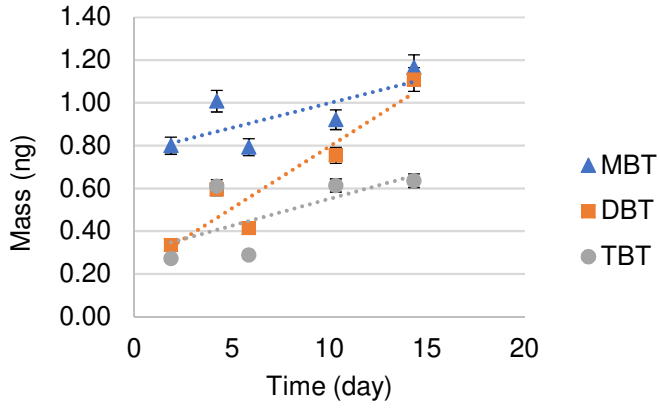

5.

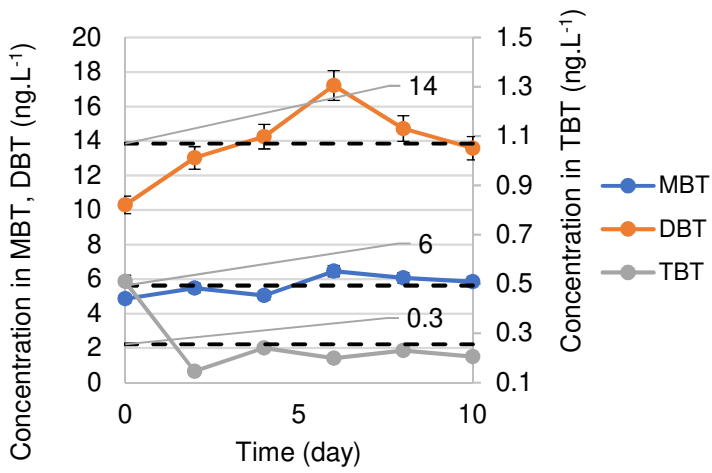

6.

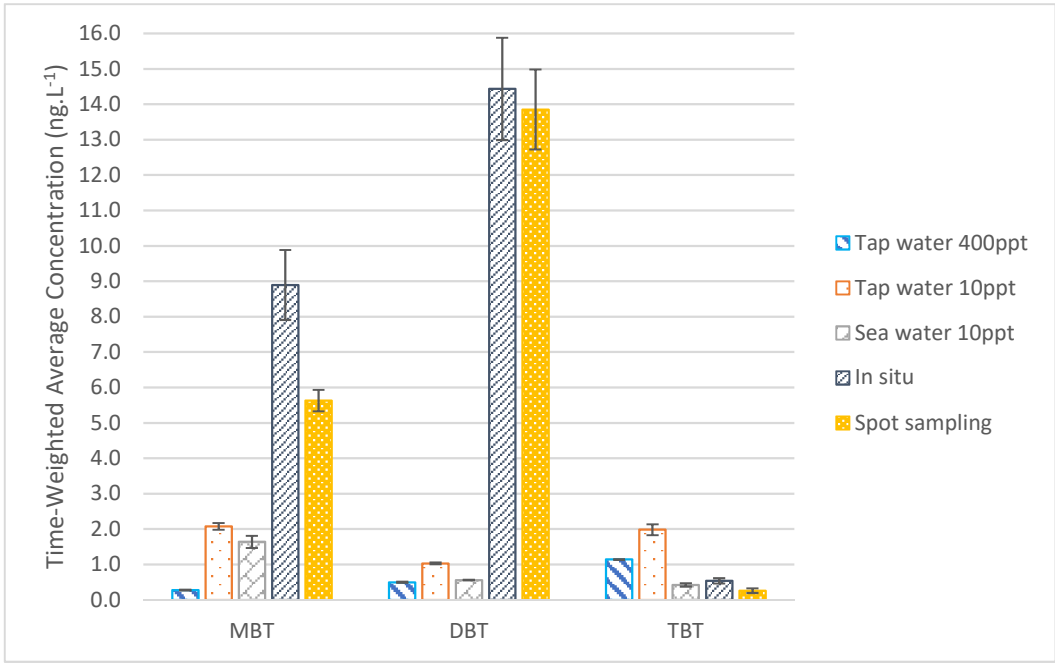

7.

Figures 2 to 7 need to be colored



Vs

Diffusion

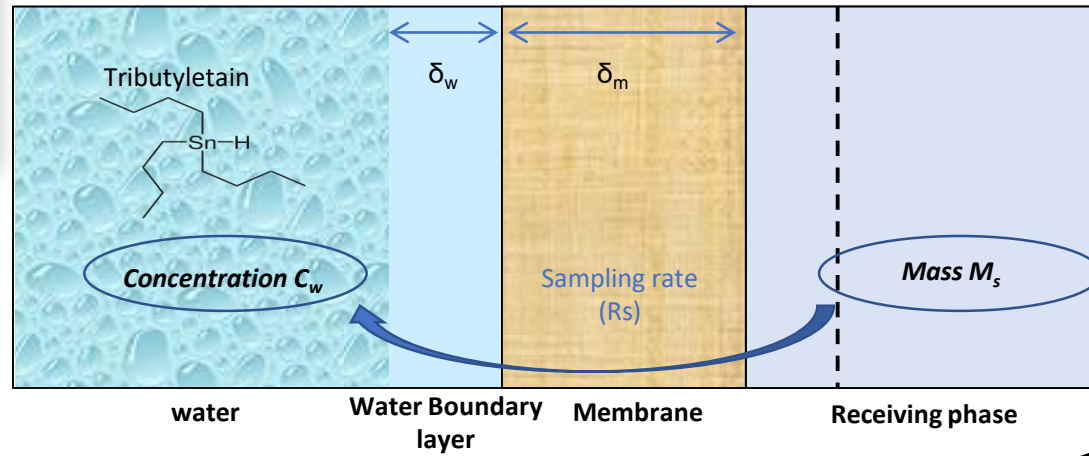

$$M_S = C_W R_S t$$

Vs

400 ng/L

10 ng/L